

Unless otherwise specified: Dimensions are in millimeters. Tolerances according to DIN/ISO 2768-mK. Debur and break sharp edges. Material to comply with EU RoHS Directive 2002/95/EC.	Rev.By:	Rev.Date:	Sheet 1 of 2
	Material:		
 Lyngdorf Audio, Denmark <a href="http://www.lyngdorf.com">www.lyngdorf.com</a>	Finish:		Date: 01-12-2020
	Colour:	Weight:	Creator: Brian Nielsen
	Description: <b>D-5</b>		Part No.:
 Scale: Not to scale			

Including Grill

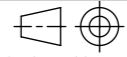
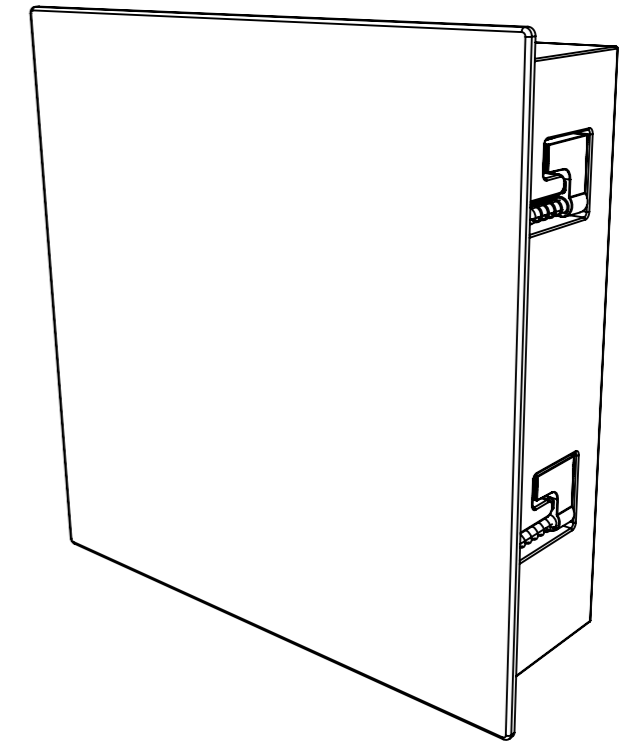
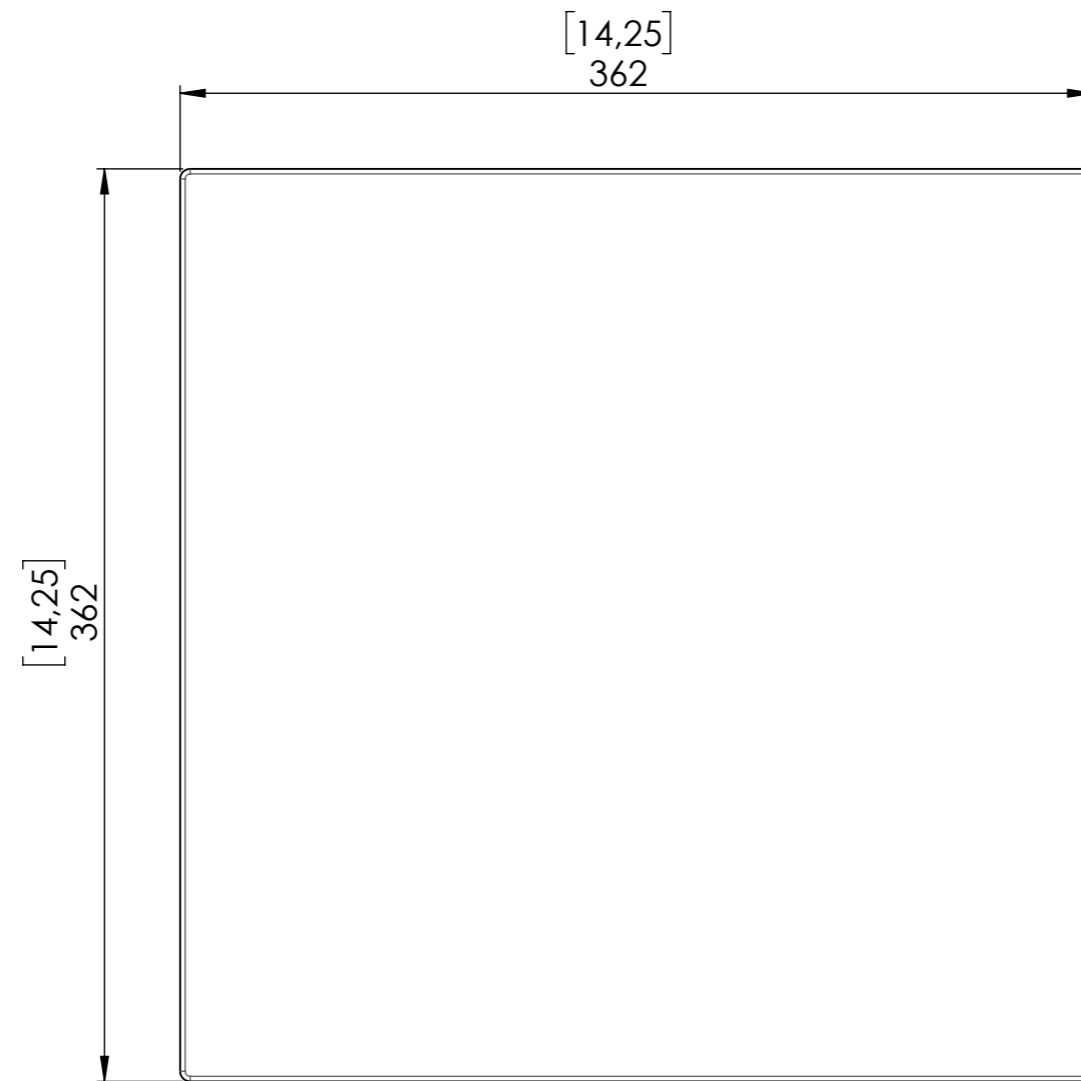
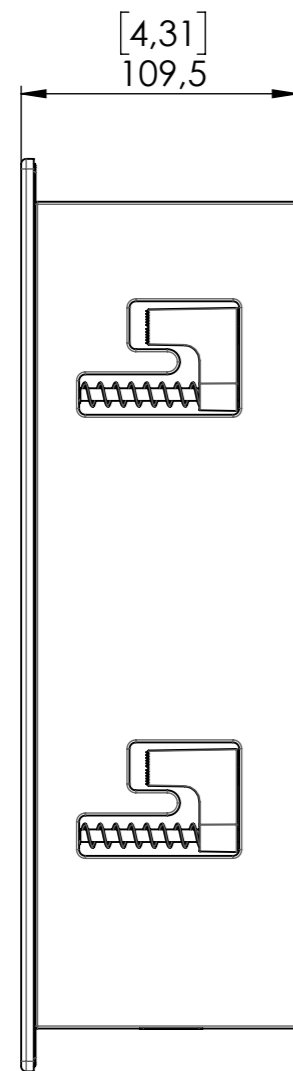
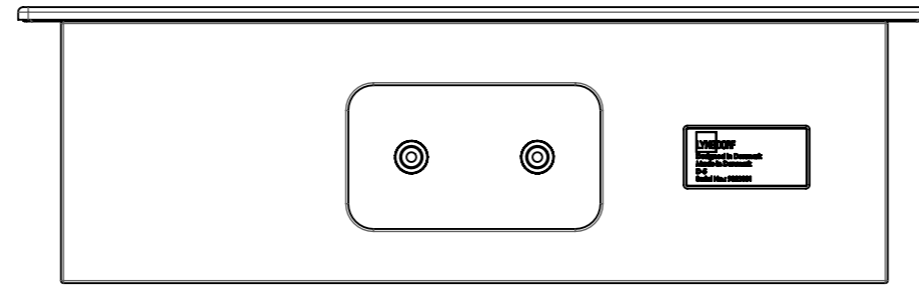

Unless otherwise specified:

Dimensions are in millimeters.  
Tolerances according to DIN/ISO 2768-mK.  
Debur and break sharp edges.

Material to comply with EU RoHS Directive 2002/95/EC.



Lyngdorf Audio, Denmark  
www.lyngdorf.com

Proprietary and confidential.  
The information contained  
in this drawing is the sole  
property of Lyngdorf Audio.  
Any reproduction in part or  
as a whole without the written  
permission of Lyngdorf Audio  
is prohibited.

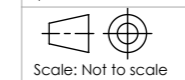

Rev.By:	Rev.Date:	Sheet 2 of 2
Material:		
Finish:		Date: 01-12-2020
Colour:	Weight:	Creator: Brian Nielsen
Description: <b>D-5</b>		
Part No.:	(Revision)	