

**MODEL**  
R18s SUBWOOFER



**TECHNICAL SPECIFICATIONS**

APP Control - iOS and Android



Advanced APP User interface - customizable turn-on controls and input selection, multiple PEQ's with presets.

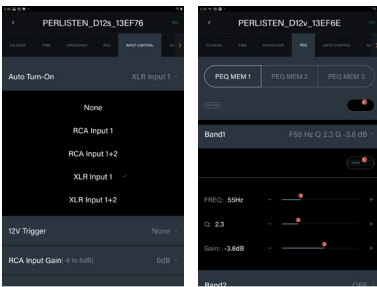

<b>Alignment</b>	Acoustic suspension
<b>Amplifier</b>	1.0kW rms
<b>Display Interface</b>	2.4" LCD color touchscreen
<b>App</b>	iOS and Android
<b>Processor</b>	32-bit ARM Cortex M4, double precision floating point math
<b>DSP Engine</b>	Ti DSP 48-bit data paths
<b>Driver compliment</b>	460mm, Glass fiber diaphragm +/-23.7mm linear excursion
<b>Reference sensitivity</b>	95dB / 150mV/ 1.0m
<b>Frequency Response</b>	THX EQ Boost (Large Room) EQ Cut (Small Room) EQ
<b>Inputs</b>	(1) Balanced XLR (1) Unbalanced RCA
<b>Outputs</b>	(1) Balanced XLR unbuffered (1) Unbalanced RCA unbuffered
<b>Parametric EQ</b>	10-Band PEQ with 3 user presets
<b>Low Pass filter</b>	bypass, 30-160Hz, slope 6,12,18,24dB/oct
<b>Phase</b>	variable 0-270°
<b>Polarity</b>	normal / inverted
<b>Configurable Auto turn-on and 12v Trigger</b>	XLR 1, RCA
<b>Dimensions overall (HxWxD)</b>	618 x 570 x 575mm 24.3 x 22.4 x 22.6"
<b>Weight</b>	57.3 kg (126.1 lbs.)

**DESCRIPTION**

R-Series subs - Trickle down technology from our flagship D-Series, we've developed a lineup of single driver based subwoofers. Ground up drivers developed by our team of engineers. Glass fiber composite diaphragms, multiple aluminum shorting rings, massive magnets, multi-layer Nomex spiders and lightweight aluminum voice coil wire are the key ingredients - Proprietary nonlinear modeling techniques allow us to simulate all these components and then optimize for real world driver performance - free air and in box. Further refinement is done with the aid of our Klippel laser measurement system to dial things in. Powered by our new 1.0kW amplifier, all functions and safeties are controlled by a 48-bit data bath DSP and 32-bit ARM M4 Cortex processor, able to react in microseconds ensuring sonic accuracy. All R-Series subs share our 2.4" LCD touchscreen display and ability to control advance settings using our App.

4 3 2 1

D C B A

REVISIONS	
REV.	DESCRIPTION
1	initial drawing
	DATE
	20230103

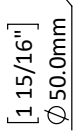
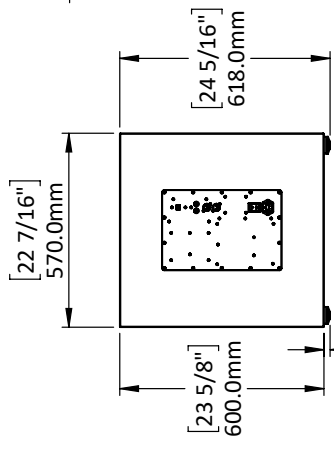
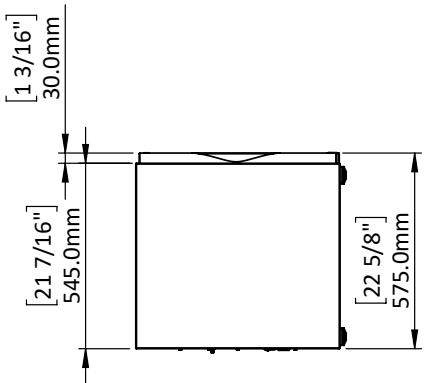
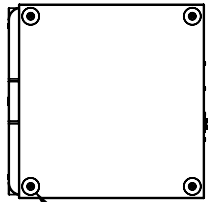
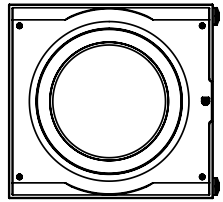
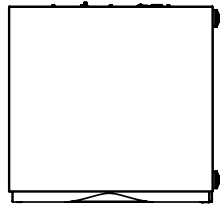
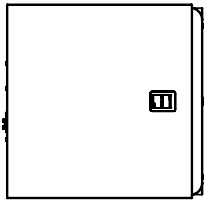
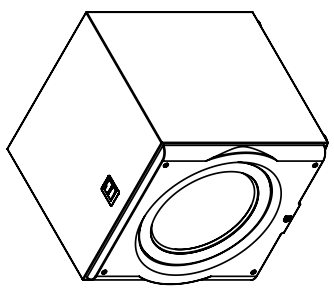

Notes:

**PROPRIETARY AND CONFIDENTIAL**  
 THE INFORMATION CONTAINED IN THIS DRAWING IS THE SOLE PROPERTY OF PERLISTEN AUDIO, LLC. ANY REPRODUCTION IN PART OR AS A WHOLE WITHOUT THE WRITTEN PERMISSION OF PERLISTEN AUDIO, LLC IS PROHIBITED.  
 DIMENSIONS IN MILLIMETERS DO NOT CONTROL DRAWING



NAME	DATE
	1/3/2024

TITLE: Sheet1

SIZE	DWG. NO.	REV
A	Perlisten R18s_Architectural_20230103	1
	SCALE: 1:20	SHEET 1 OF 1

2 3 1